

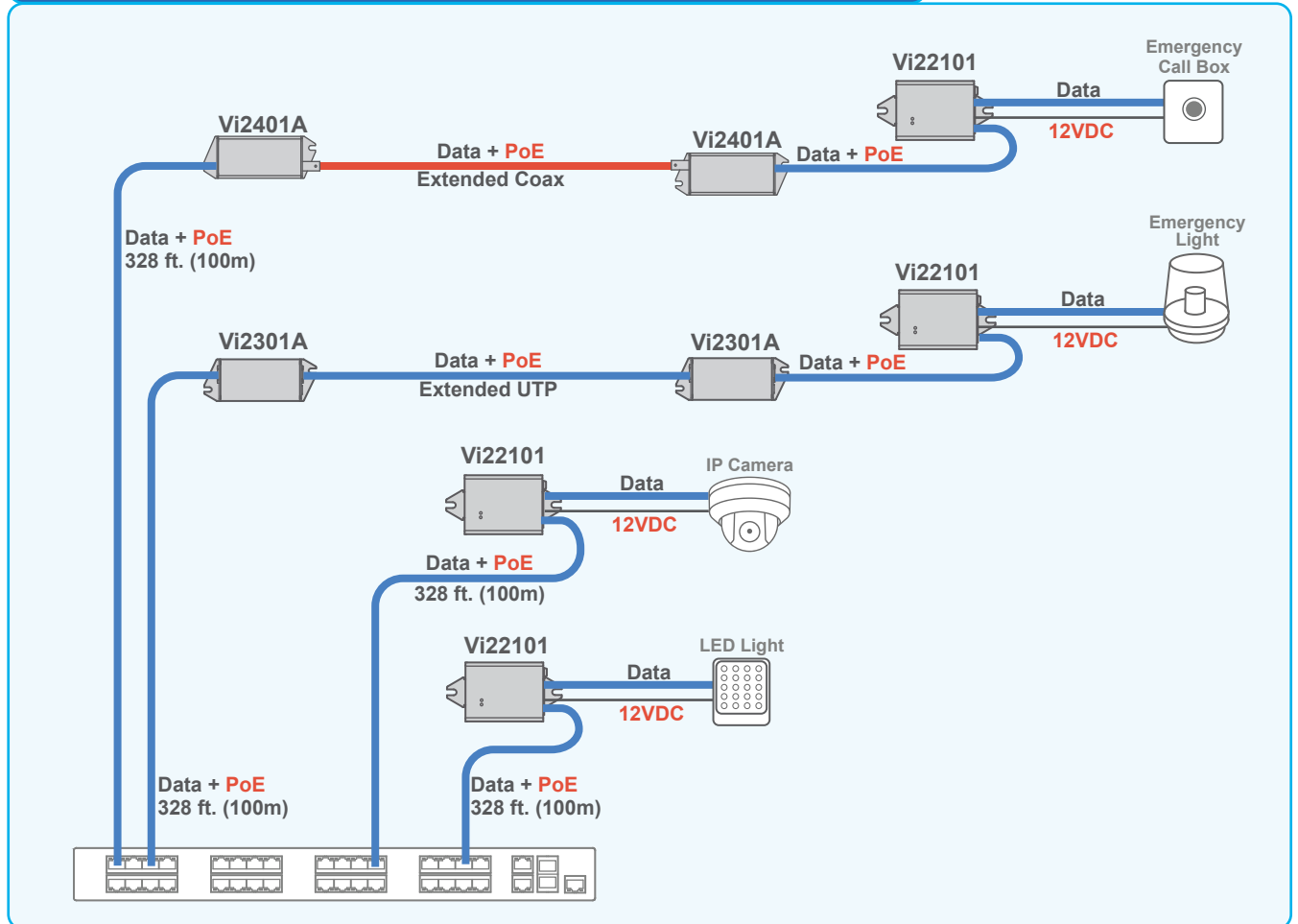

Powering non-PoE devices at standard and extended distances



The Vi22101 can power a wide range of PoE devices at standard and extended distances up to 12W.