

The Vi3003 is a 3-port Layer 2 Ethernet and PoE switch providing drop and insert capability for connecting several IP devices along a single cable run. The Vi3003 provides a cost effective method for increasing distances beyond the standard Ethernet limit of 328 feet (100m) for 10/100/1G Mbps Ethernet. Multiple units can be cascaded to provide up to nine IP cameras to be connected to a single network switch port over distances of up to 3,000 feet (909m).

For small systems, the Vi3003's Layer 2 network capability can eliminate the need for network switches saving costs and rack space. It also can significantly decrease network switch costs by increasing the capacity of a 24-port switch to handle up to 216 cameras and an 8-port switch up to 72 cameras. As a mini network switch, the Vi3003 avoids the potentials for transmission collisions by complying with IEEE standards. Its ability to automatically sense the datarate up to 1000Mbps (1Gbps) also makes it the perfect solution for cost effectively extending network to network communications or between network switches requiring high speeds transmission.

The Vi3003 can be powered from a single PoE source or a local power supply. Additional power up to 60W can be added at any point along the cable run where power outlets are available providing the ability to power IP cameras up to 60W.

## Important Safety Warning

- Read these instructions.
- Keep these instructions.
- Heed all warnings.
- Follow all instructions.
- Do not use this apparatus near water.
- Clean only with a dry cloth.
- Install in accordance with the manufacturer's instructions.
- This installation should be made by a qualified service person and should conform to all local codes.
- DO NOT bundle UTP or coax signals in the same conduit as high-voltage wiring.
- To reduce the risk of fire or electrical shock, do not expose these products to rain, moisture, dripping or splashing.
- No objects filled with liquids, such as vases, shall be placed on Vigitron equipment.
- DO NOT install the unit in a place where the operating ambient temperature exceeds 75°C.
- Make sure that the external power supply output voltage is in the recommended range.
- Do not install near any heat sources such as radiators, heat registers, stoves or other apparatus that produce heat.
- Protect the power cord from being walked on or pinched particularly at plugs, convenience receptacles, and the point where they exit from the apparatus.
- Only use attachments/accessories specified by the manufacturer.
- Unplug this apparatus during lightning storms or when unused for long periods of time.
- Refer all servicing to qualified service personnel. Servicing is required when the apparatus has been damaged in any way, such as a power supply cord or plug is damaged, liquid has been spilled, or objects have fallen into the apparatus, the apparatus has been exposed to rain or moisture, does not operate normally, or has been dropped.
- The power plug and the PoE input cable are used as the disconnect device and shall remain readily

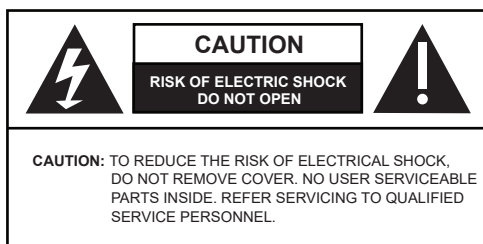

**WARNING!** - To reduce the risk of fire or electric shock, do not expose this apparatus to rain or moisture. This apparatus shall not be exposed to dripping or splashing and no objects filled with liquids, such as vases shall be placed on the apparatus.

**WARNING!** - This apparatus is a Class I product. This product must be connected to a main socket outlet through an AC to DC Power supply.

**WARNING!** - The main plug is used as the disconnect device and shall remain readily operable.

## Application Drawings

### Providing PoE to 2 Cameras using a Local Power Supply

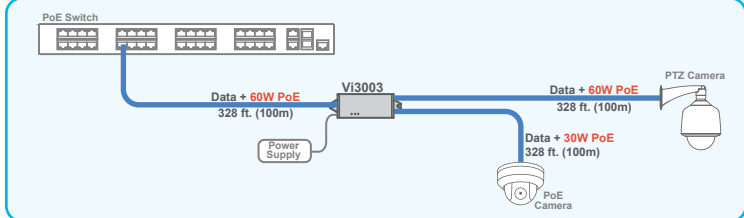

Vi3003 allows for the transmission of two cameras over a single cable run or adding a new

### Providing PoE to 2 Cameras using input PoE

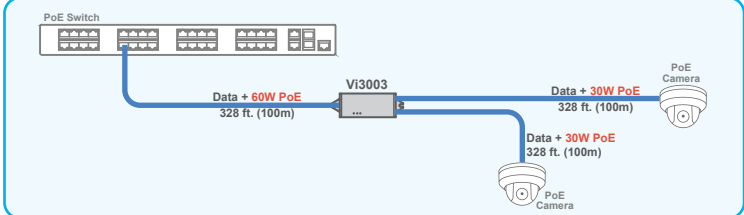

Vi3003 allows for the transmission of two cameras over a single cable or adding a new camera close to an existing camera. The PoE Midspan provides power to the Vi3003 and both cameras.

### Drop and Insert Application

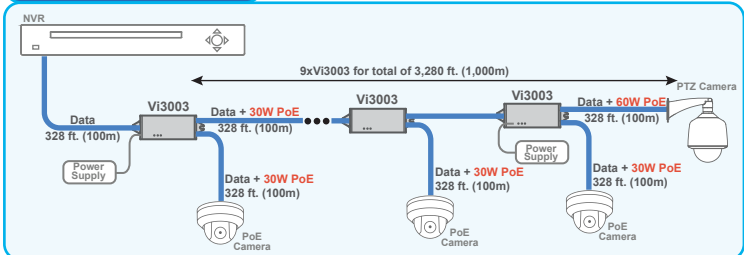

A total of 9 IP addresses can be accessed on a single cable run eliminating the need for network switches.

### 1G Extended Connection between Networks

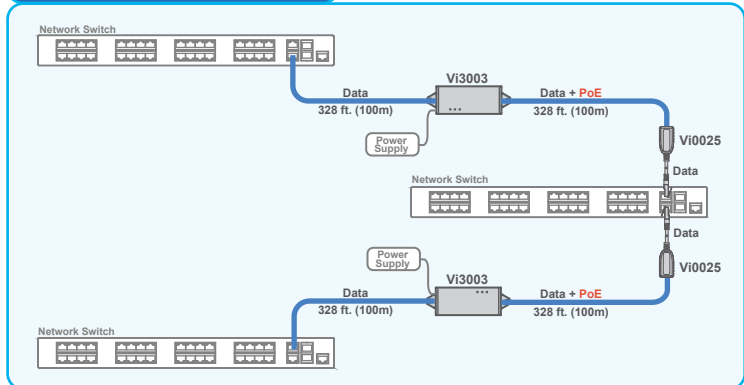

Vi3003 enables extending 1G connection between networks.

## Installation (Powered by PoE)

### a) Port-3 (Tap) Connection:

- Connect the IP camera's RJ45 connector to the Port-3 of Vi3003 using a standard Cat5/6 cable of maximum 100m in length. This port can provide up to 30W PoE power depending on the input PoE and the total load on the unit.

### b) Port-2 (PoE-Out) Connection:

This port can be used to connect to another Vi3003 or a 60W camera.

- If you want to daisy-chain this unit with another Vi3003, connect Port-2 of Vi3003 to the Port-1 of the next Vi3003 using a standard Cat5/6 cable of maximum 100m in length. Port-2 will provide 1G Ethernet.
- If you want to connect this unit to a PoE++ camera, connect Port-2 of Vi3003 to the RJ45 connector of the IP camera using a standard Cat5/6 cable of maximum 100m in length. This port can provide up to 60W PoE power depending on the input PoE and the total load on the unit.

### Caution

Do not connect a non-PoE device to the Port-2 of the Vi3003. Doing so may damage the non-PoE device.

If it is necessary to connect a non-PoE device to Port-2, use a Vi0025 between Port-2 and RJ45 connector of the non-PoE device.

### c) Port-1 (PoE-In) Connection:

- Connect Port-1 of Vi3003 to the PoE switch or a high power PoE source using a standard Cat5/6 cable of maximum 100m in length. This port can receive up to 74W PoE and data 1Gbps.

## Installation (Powered by Local Power Supply)

### a) Port-3 (Tap) Connection:

- As "a" in previous section.

### b) Port-2 (PoE-Out) Connection:

- As "b" in previous section.

### c) Port-1 (PoE-In) Connection:

- Connect Port-1 of Vi3003 to the network switch using a standard Cat5/6 cable of maximum 100m in length.

### d) Power Connection:

- Connect power connector to Vi1120 120W desktop power supply for using full PoE capacity of Vi3003. If the application does not provide PoE, a Vi0014 can be used for just powering the Vi3003.

## Drawings

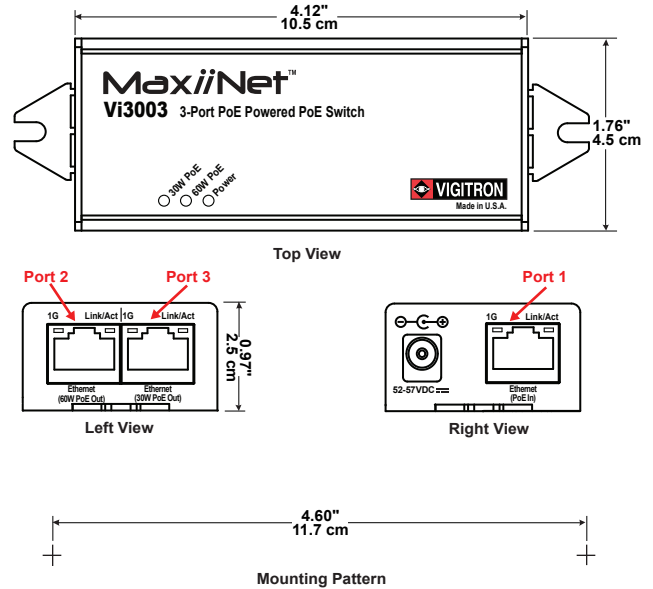

## Technical Specifications\*

### Electrical

PoE Rating	Port 1 (PoE In): 60W Port 2 (PoE Out): 60W Port 3 (Tap): IEEE 802.3af, at (30W/60W)
Network Connection	(3) RJ-45 IEC 60603-7 connectors
Wiring Support	Cat 5/5e/6
Power Consumption	3W
Supported Distance	328 ft (100m) per link
PoE Supported	IEEE 802.3af, at, bt and UPoE
Status LEDs	Power: Green 30W PoE Output: Orange 60W PoE Output: Orange Port 1 (Uplink): 1G (Green), Link/Act. (Yellow) Port 2: 1G (Green), Link/Act. (Yellow) Port 3 (Tap): 1G (Green), Link/Act. (Yellow)
Data Rate	Auto Configuring Port 1: 10/100/1000Base-TX Port 2: 10/100/1000Base-TX Port 3 (Tap): 10/100/1000Base-TX
Data Interfaces and	RFC 768 UDP, RFC 2068 HTTP
Compliances	RFC 793 TCP, RFC 791 IP RFC 1783 TFTP, RFC 894 IP over Ethernet RFC 2544 TCP/IP Packet Transmission IEEE802.3af, 8IEEE02.3at
IEEE Compliances	802.3ab, 802.3z, 802.3af, 802.3at, 802.1p, 802.1Q, 802.1D, 802.1s, 802.3u, 802.3x, 802.3w
Service Compliance	IPv4 Type of Service (TOS) and Differentiated Services (Diff-Serv) IPv6 Traffic Class
VLAN Support	4,096 Addresses
Jumbo Frame	Up to 10,000 bytes

### Regulatory

Safety	CE
Environmental	RoHS, WEEE

### Environmental

Humidity	0 to 95%, non-condensing
Temperature	Operating: -40°C to +75°C per NEMA-TS2 testing Storage: -40°C to +85°C

### Mechanical

Dimensions	0.97x1.76x4.12 in., 2.5x4.5x10.5 cm (HxWxL)
Weight	0.26 lb, 117 g
Material	Extruded Aluminum

\*Specifications subject to change without notice.

## Status LEDs

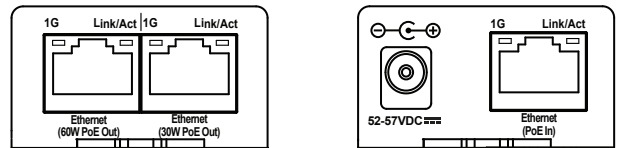

LED	Color	Status	Function
Power	GREEN	OFF	The Vi3003 is off
		ON	The Vi3003 is on
60W PoE	YELLOW	OFF	No PoE is present on Port-2
		ON	PoE is present on Port-2
30W PoE	YELLOW	OFF	Port-3 PoE is off
		ON	Port-3 is delivering PoE
		FLASHING	PoE voltage is out of range
Ports 1,2,3	GREEN	OFF	10/100Mbps Connection when Linked
		ON	1000Mbps Connection
		ORANGE	No Link
		ORANGE	Link flashes with Activity

## Ordering Information

### Ordering Information

Part No.	Description
Vi3003	1G Drop and Insert 3-Port 60W PoE Switch

### Related Products

Part No.	Description
Vi3103	Drop and Insert 3-Port 30W PoE Switch
Vi3003WP	IP67 1G Drop and Insert 3-Port 60W PoE Switch

## Limited Lifetime Warranty

Vigtron, Inc. warrants that all Vigtron products ("Product"), if used in accordance with these instructions, will be free of defects in material and workmanship for lifetime defined as the duration period of time until product end of life is announced. After which, Vigtron will continue to provide warranty services for a period of 3 years. Period covering valid warranty will be determined by proof of purchase in the form of an invoice from an authorized Vigtron dealer.

Warranty will only be provided for as long as the original end user purchaser owns the product. Warranty is not transferrable. At Vigtron's option, defective product will be repaired, replaced or substituted with a product of equal value. This warranty does not apply if, in the judgment of Vigtron, Inc., the Product fails due to damage from shipment, handling, storage, accident, abuse or misuse, or if it has been used or maintained not conforming to Product manual instructions, has been modified, or serial number removed or defaced. Repair by anyone other than Vigtron, Inc. or an approved agent will void this warranty. Vigtron, Inc. shall not under any circumstances be liable to any person for any incidental, indirect or consequential damages, including damages resulting from use or malfunction of the product, loss of profits or revenues or costs of replacement goods. The maximum liability of Vigtron, Inc. under this warranty is limited to the original purchase price of the Product only.

