

Vi2301AU

90W PoE Ethernet Extender over UTP

Features

- Extends Pass Through PoE (EPTP™) compatible with 802.3af, at, bt up to 90W
- Extends Ethernet beyond 328 feet (100 m) limitation up to 3,000 feet (914 m) over UTP cables
- Requires no switch setting or network programming
- Mega-Pixel Certified (MPC™) High data rate, ideal for high bandwidth requirements of Mega-pixel cameras and cameras requiring Jumbo Frame transmission
- Symmetric Bandwidth (SBW™) provides consistent upload and download with Virtual Zero Packet Loss (VZPL™)
- Type tested to RFC-2544 TCP/IP network bandwidth packet transmission standards
- Supports one-pair or four-pair UTP wires with built-in transceiver cable connectivity tester
- Type tested for -40°C to +75°C temperature range under conforming to NEMA-TS2 standards
- Data rate selectable to for maximum bandwidth utilization
- Complies to major IEEE standards and RFC network protocols for UDP, TCP/IP, HTTP/HTTPS



Applications

- Extending Ethernet distances beyond Ethernet 100 m limit
- Solution for powering multi-sensor and PTZ cameras requiring more than 50W PoE
- Retrofit UTP analog CCTV installations into Digital systems
- Providing high power PoE to PTZ cameras at long distances
- CCTV System for Casinos, Airports, School Campuses

Vigitron's MaxiiCopper™ Vi2301AU UTP Ethernet extender brings new performance standards to the growing need for high speed transmission of full bandwidth Ethernet and 90W PoE power over extended distances. The Vi2301AU provides a solution for Multi-sensor and PTZ domes requiring PoE power between 60W to 70W for distance up to 900 feet. Its unique Symmetric Bandwidth (SBW™) assures full bandwidth transmission is maintained over the entire specified distance for both upload and download data with Virtual Zero Packet Loss (VZPL™). Bandwidth assurance provides the ability to transmit multiple cameras on single cable runs with no information loss. It can use 1 pair or 4 pairs of UTP and requires no switch setting or network programming. The Vi2301AU is compatible with all Vi2300A series models but in order to benefit from maximum PoE transmission the Vi2301AU need to be used on both ends of the cable.

Extended Pass-Through 90W PoE eliminates the need for additional remote site power while allowing a PoE source, such as a PoE network switch, to provide power to both transceivers and the camera. The Vi2301AU can pass through 802.3bt PoE power up to 90W. It is type tested under NEMA-TS2 environmental standards for extended operation temperature between -40°C to +75°C. The Vi2301AU is the perfect solution for extended distance data and power transmission for warehouses, parking lots, campuses, casinos, etc. MaxiiCopper's Vi2301AU is low power and can easily fit inside most cameras housings and junction boxes. Best of all, it is MegaPixel Certified (MPC™), type tested to network packet performance standards, and major camera brand compatibility tested to assure error free and reliable operations.

Technical Specification*

Electrical

Ethernet Interface	Standard 10/100BaseT
Pass-Thru PoE	PoE Class 0-8 up to 90W
Data Rate	Auto select 10/100Mb/s Full speed / full duplex at maximum rated distance
UTP	100 Ohm +/- 20%, Cat5, 5e, 6, 6a 10BaseT: up to 3,000 ft. (914 m) 100BaseT: up to 2,100 ft. (640 m)
Power Consumption	12VDC, 24VAC, POE af/at @150 mA maximum 1.5W with external power supply, 2W using PoE
Status LEDs	Power On Standard Ethernet: Traffic, Link Extended Ethernet: Traffic, 10/100BaseT
Connectors	Ethernet Interface: RJ-45 Connector Extended Ethernet Interface: RJ-45 Connector Power: 2.5mm Round Barrel Connector
RFC	2544 TCP/IP Packet Transmission 768 UDP, 2068 HTTP, 793 TCP 791 IP, 1783 TFTP, 894 IP over Ethernet
PoE Compatibility	IEEE 802.3af/at/bt Compliant
Jumbo Frame	Up to 9,600 bytes

Regulatory

FCC	Part 15, Subpart B, Class B 2010
Emissions	EN 5502:2006+A1:2007 EN 61000-3-2:2006+A1:2009+A2:2009 EN 61000-3-3:2008 EN 55024:1998+A1:2001+A2:2003
Safety	CE
Environmental	RoHS

Environmental

Humidity	0 to 95%, non-condensing
Temperature	Operating: -40°C to +75°C per NEMA-TS2 testing Storage: -40°C to +85°C

Mechanical

Dimensions	1.15x1.6x3.73 in., 3.0x4.0x9.5 cm (HxWxL)
Weight	0.212 lb, 96 g
Material	Extruded Aluminum

Ordering Information

Part No. Description

Vi2301AU	Single port UTP Ethernet Extender
-----------------	-----------------------------------

Related Products

Part No. Description

Vi2300A	Single port Mini UTP Ethernet Extender
Vi2300WP	Single port IP67 UTP Ethernet Extender
Vi2301A	Single port UTP Ethernet Extender
Vi2304A	4-port UTP Ethernet Extender
Vi2308A	8-port UTP Ethernet Extender
Vi2316A	16-port UTP Ethernet Extender
Vi2508	8-port Extended UTP Midspan
Vi2516	16-port Extended UTP Midspan
Vi2701RX	Single port Extended UTP Midspan
Vi0012	12 VDC Wall-mount Power Supply

* Specifications subject to change without notice.



TEL (+1) 858-484-5209 • FAX (+1) 858-484-1205

7810 Trade Street, Suite 100, San Diego, CA 92121, USA • support@vigatron.com • www.vigatron.com

© Copyright 2021 Vigatron, Inc.

Technical Specification*

PoE Performance of Vi2301AU over Different UTP Cables²

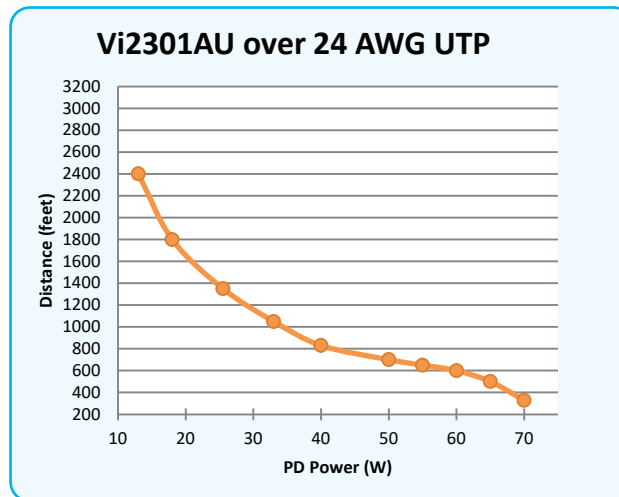
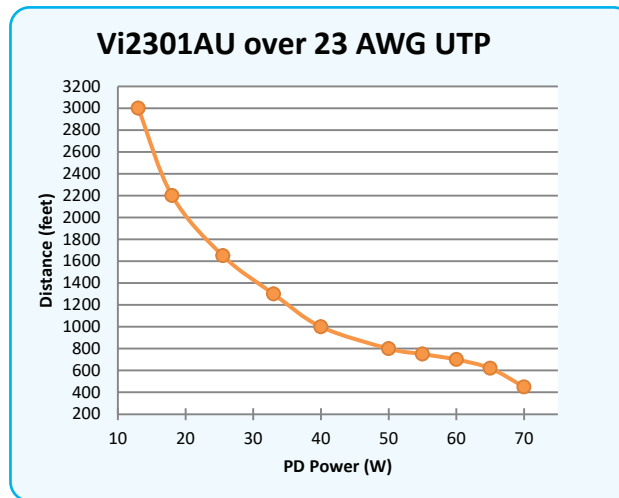
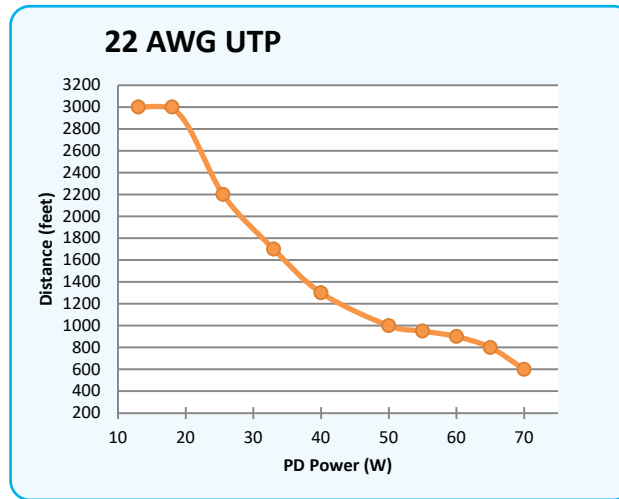

2. The Vi2301AU is used at both ends of the cable.



Mechanical Drawings

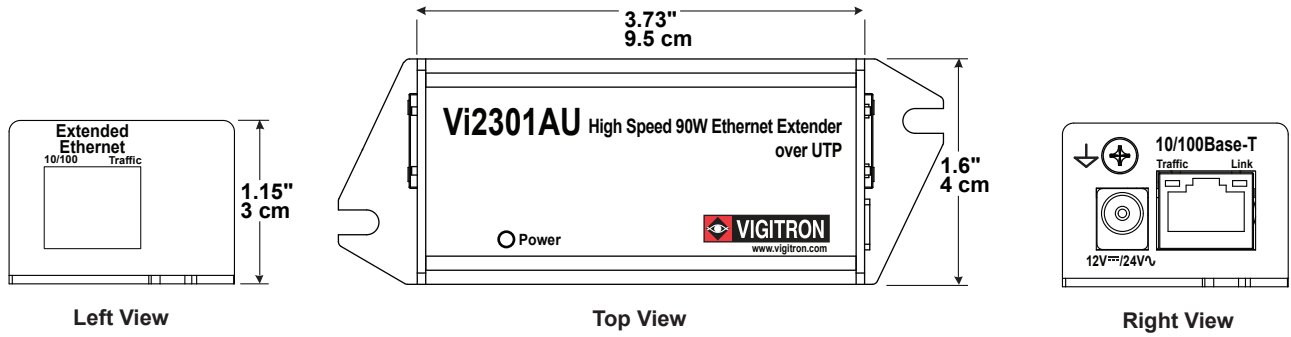

Application Drawings

— Cat 5/6

Extending Ethernet and 90W PoE from a PoE Switch

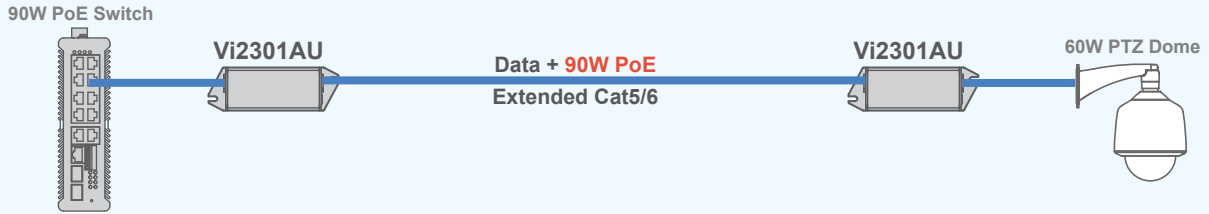

The Vi2301AU extends Ethernet and 90W PoE from a PoE switch.

Extending Ethernet and 90W PoE from a Switch & PoE Midspan

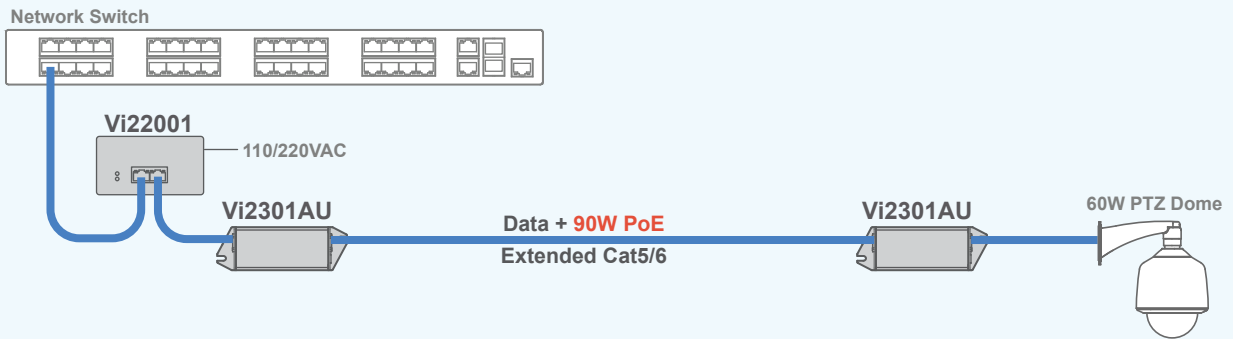

The Vi2301AU extends Ethernet and 90W PoE from a PoE Midspan.

Connecting Multiple PoE Cameras at Extended Distances

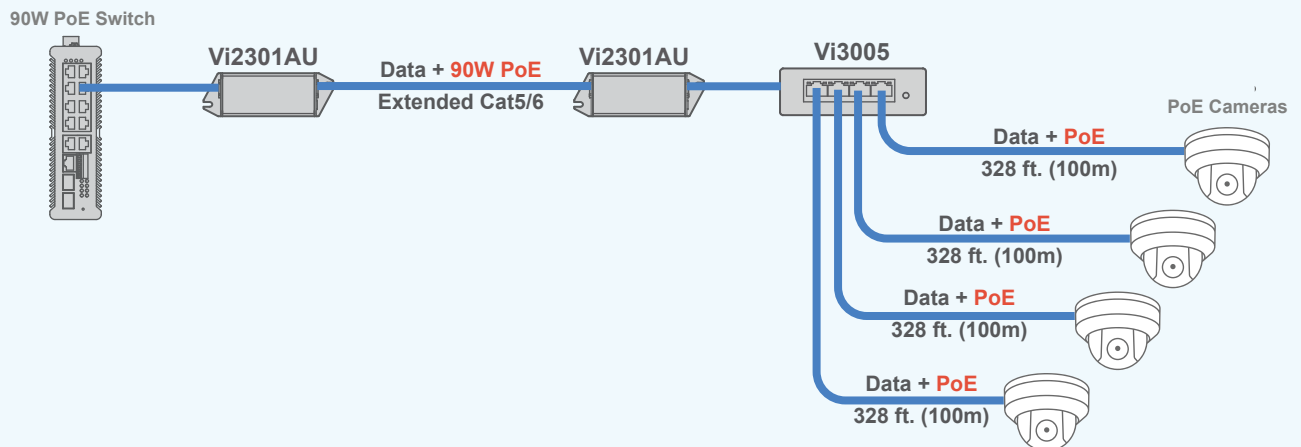

The Vi2301AUs and Vi3005 can be used to connect multiple PoE cameras at extended distances.