

Multiple DIN Rail devices mounted on 19" Rack

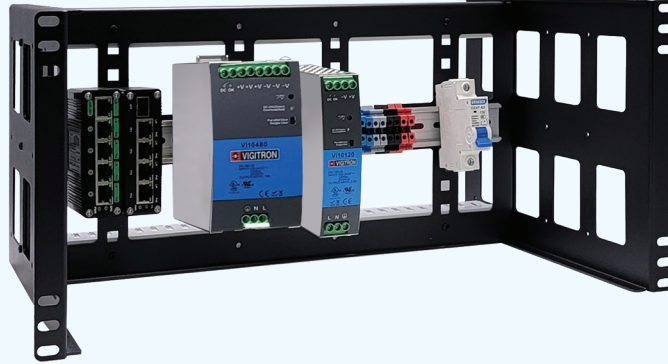

Multiple DIN Rail can be mounted on the Vi00115.

Mounting Cable ducts



Front View

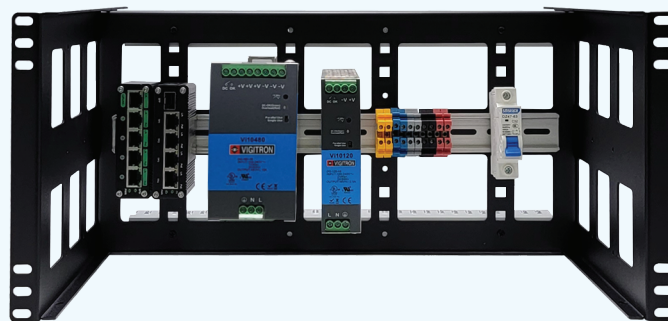

Rear View

The Cable Duct can be installed on the top or bottom row on either side of the back panel of Vi00115.

Adjustable Depth



The back panel can be mounted at 4 different position to provide the desired depth.

Adjustable DIN Rail Mounting

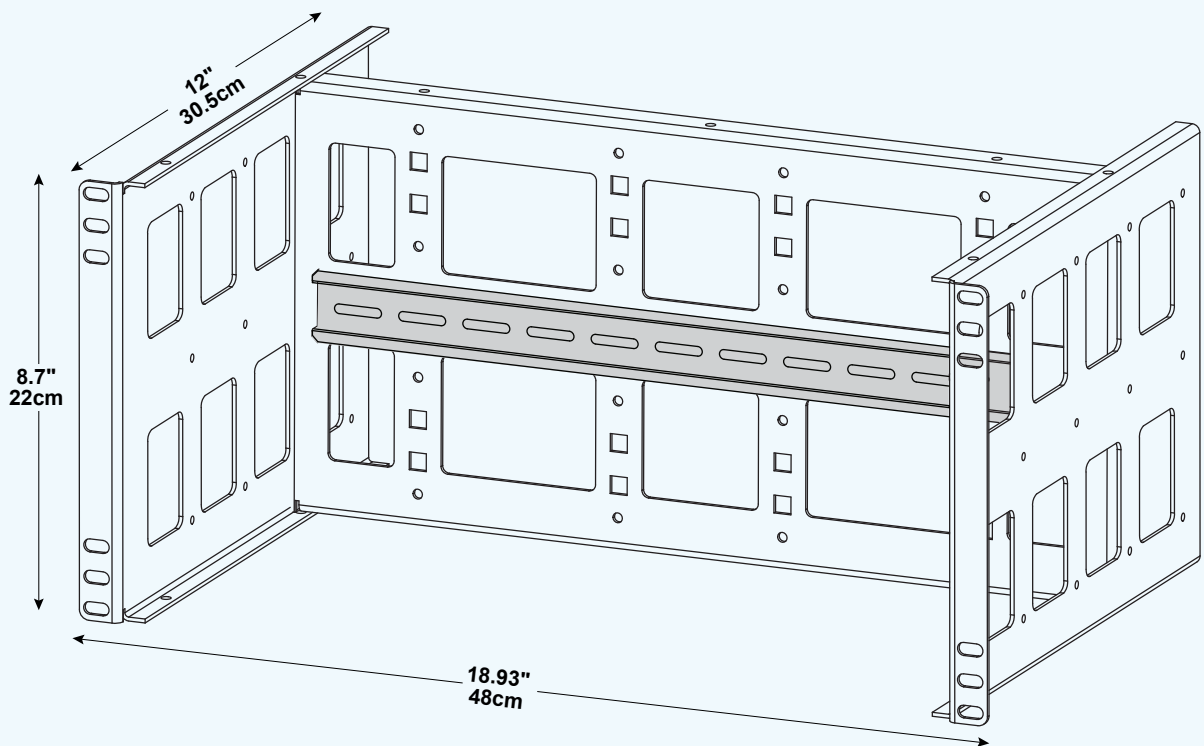

The DIN Rail can be mounted at 3 different height.